

Inverquark | AQUAGEM®

Full InverEasy

POOLFILTERPUMPE ZUR ANWENDUNG IM PUMPENTAUSSCH



INVERSilence® Tech

Modell	P1 (kW)	Spannung (V/Hz)	Qmax (m³/h)	Hmax (m)	Q at 8 m (m³/h)	Q at 10 m (m³/h)
DKF10	0,50	220~240	20,0	14,0	11,5	10,0
DKF15	0,66		21,0	15,0	15,0	11,0
DKF19	0,80	50/60	23,5	17,0	19,0	14,5
DKF23	1,10		27,0	19,0	25,0	20,0

Leistungskurven

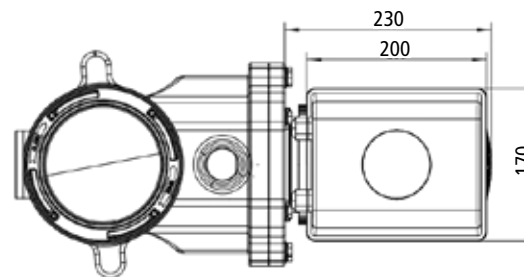
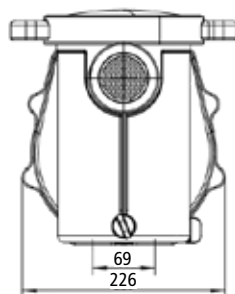
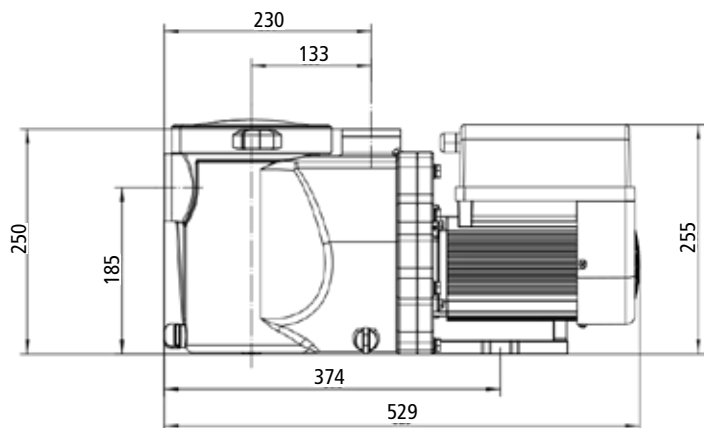
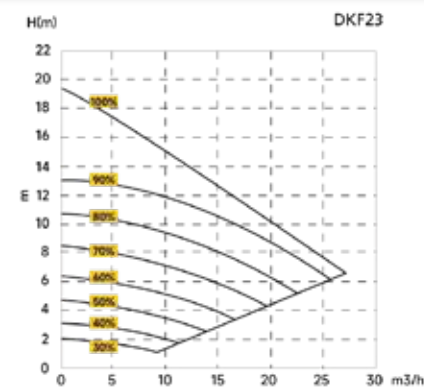
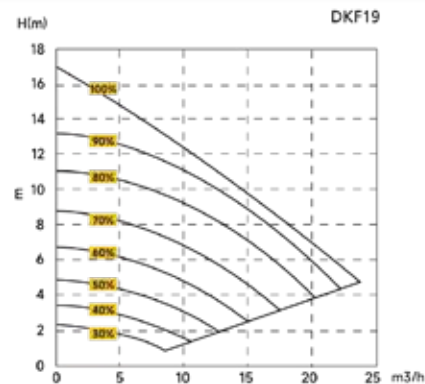
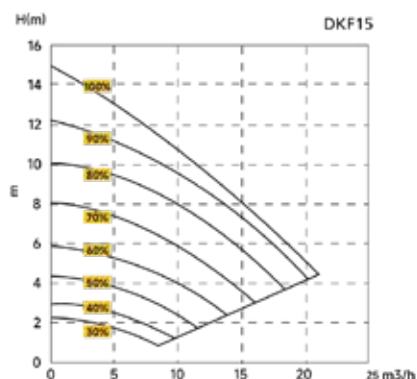
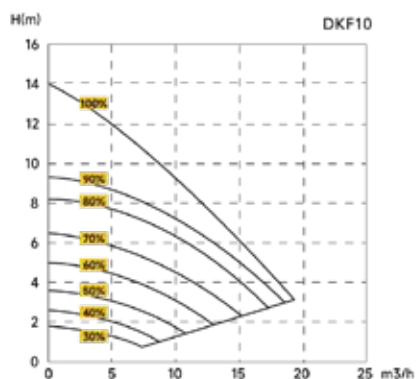

Bis zu 10-fach energieeffizienter

IE4-Motor Skimmer-Modus

Stromverbrauchsanzeige

Geräuschpegel bis zu 36 dB(A)

Kompatibel mit iWash

AI/MI Modus für maximale Effizienz

